

Why to be the largest ...



CATALOGUE

**Hoses, fittings, hose connectors and
accessories**



... if you can be the best !

HYDRATECH s.r.o.

Table of contents

Introduction	4
Fundamental information	5
Hydraulic hoses	6
BSP fittings	8
DKJ fittings	15
AGJ fittings	17
Banjo Eye Nipple	19
Connecting Nipples	20
ORFS fittings	22
Komatsu, Toyota	26
Double insert & WashCleaner Felame	27
SFL fittings	28
SFS fittings	31
FHL, FHS fittings	37
Metric Banjo Nipple	38
Reusable Ferrules	41
Hydraulic ball valves	46
Quick couplings	47
Manometers	48
Conclusion	49

Introduction

Dear friends,

I have the honor to inform you about the activities performed by our company. History of the company Hydratech s.r.o. is bound with the year 2004 when all of our activities were created by joining of two entrepreneurs, experts in the field of hydraulic hoses, machineries and hydraulic systems.

Our program includes production, assembly and supply of hydraulic hoses (high-pressure, low-pressure hoses, air hoses and hoses used in chemical and petrochemical industry etc.), end fittings, quick couplers, worm-drive hose clips etc.

During its relatively short existence the company Hydratech s.r.o. has gained a broad range of experience because of its high level products and services, customers friendly approach, know-how and knowledge.

In 2005 we came to be the member of Slovak Chamber of Commerce and do cooperation with its departments.

Very beneficial cooperation has been started with one of the largest parcel service company, therefore we are able to deliver the whole range of our products not only in the EU member states but all around the world.

Please have a look at our catalogue and if it invokes from your interest, do not hesitate and contact us at the address mentioned below.

Ladislav Sárkány
executive head

4

address: ul Z. Kodályya 764/37
924 00 Galanta
Slovak republic

IČO: 36267091
IČ DPH: SK 2021917766
Account No.: 2629090057/1100
Skype: hydratech.s.r.o

tel:+421 31 780 42 46
fax:+421 31 780 42 45
email: office@hydratech-slovakia.eu
<http://www.hydratech-slovakia.eu>

Spoločnosť je zapísaná v Obchodnom registri Okresného súdu Trnava, oddiel Sro, vložka č. 15610/T
The company is signed in the Companies register of The District Court Trnava, section Sro, insert No: 15610/T

HYDRATECH s.r.o.

Fundamental information

Company name: **HYDRATECH s.r.o.**

Contact: **ul. Z. Kodály 764/37
924 01 Galanta
Slovak republic**

Tel: **+421 31 780 42 46**

Fax: **+421 31 780 42 45**

Web: **www.hydratech-slovakia.eu**

Mail: **office@hydratech-slovakia.eu**

Skype: **hydratech.s.r.o**

ICQ: **352-709-924**

The company Hydratech s.r.o. is signed in the Companies register of The District Court Trnava, section Sro, insert No. 15610/T



for further information click to www.maps.google.com and type „galanta“ to Search Maps

5

address: ul. Z. Kodály 764/37
924 00 Galanta
Slovak republic

IČO: 36267091
IČ DPH: SK 2021917766
Account No.: 2629090057/1100
Skype: hydratech.s.r.o

tel:+421 31 780 42 46
fax:+421 31 780 42 45
email: office@hydratech-slovakia.eu
http: www.hydratech-slovakia.eu

Spoločnosť je zapísaná v Obchodnom registri Okresného súdu Trnava, oddiel Sro, vložka č. 15610/T
The company is signed in the Companies register of The District Court Trnava, section Sro, insert No: 15610/T

Hydraulic hoses

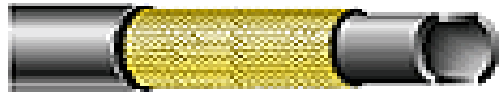

HYDRAULIC HOSE

DIN EN 853 1SN

size in mm DN	size in inches	inner diameter	extern diameter	pressure bar	pressure psi	examine pressure/bar	fault pressure/bar	inflexion mm
6	1/4"	6,4	11,1	225	3250	540	900	100
8	5/16"	7,9	12,7	215	3120	510	850	115
10	3/8"	9,5	15,1	180	2610	435	720	130
12	1/2"	12,7	18,3	160	2320	385	640	180
16	5/8"	15,9	21,4	130	1885	315	520	200
20	3/4"	19,0	25,4	105	1525	255	420	240
25	1"	25,4	33,3	88	1275	210	350	300



HYDRAULIC HOSE

DIN EN 853 2SN

size in mm DN	size in inches	inner diameter	extern diameter	pressure bar	pressure psi	examine pressure/bar	fault pressure/bar	inflexion mm
6	1/4"	6,4	15,0	400	5800	960	1600	100
8	5/16"	7,9	16,6	350	5075	840	1400	115
10	3/8"	9,5	19,0	330	4785	795	1320	130
12	1/2"	12,7	22,2	275	3990	660	1100	180
16	5/8"	15,9	25,4	250	3625	600	1000	200
20	3/4"	19,0	29,3	215	3120	510	850	240
25	1"	25,4	38,1	165	2395	390	650	300



HYDRAULIC HOSE

DIN EN 856 4SP

size in mm DN	size in inches	inner diameter	extern diameter	pressure bar	pressure psi	examine pressure/bar	fault pressure/bar	inflexion mm
12	1/2"	12,7	25,0	415	6000	995	1660	230
16	5/8"	15,9	28,3	350	5000	840	1400	250
20	3/4"	19,0	33,2	350	5000	840	1600	300
25	1"	25,4	41,3	280	4000	670	1120	340

6

address: ul Z. Kodályya 764/37
924 00 Galanta
Slovak republic

IČO: 36267091
IČ DPH: SK 2021917766
Account No.: 2629090057/1100
Skype: hydratech.s.r.o

tel:+421 31 780 42 46
fax:+421 31 780 42 45
email: office@hydratech-slovakia.eu
http: www.hydratech-slovakia.eu

Spoločnosť je zapísaná v Obchodnom registri Okresného súdu Trnava, oddiel Sro, vložka č. 15610/T
The company is signed in the Companies register of The District Court Trnava, section Sro, insert No: 15610/T

HYDRATECH s.r.o.

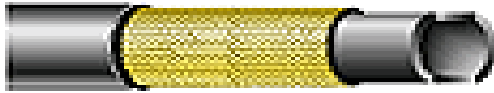

Hydraulic Hose
DIN EN 853 1SN

Code	Hose I.D.		Price in €
	DN	Poll	
HM1SN	06	1/4	
HM1SN03	08	5/16	
HM1SN04	10	3/8	
HM1SN05	12	1/2	
HM1SN06	16	5/8	
HM1SN07	20	3/4	
HM1SN08	25	1	

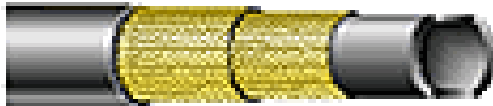

Hydraulic Hose
DIN EN 853 2SN

Code	Hose I.D.		Price in €
	DN	Poll	
HM2SN	06	1/4	
HM2SN03	08	5/16	
HM2SN04	10	3/8	
HM2SN05	12	1/2	
HM2SN06	16	5/8	
HM2SN07	20	3/4	
HM2SN08	25	1	



Hydraulic Hose
DIN EN 856 4SP

Code	Hose I.D.		Price in €
	DN	Poll	
HM4SP	12	1/2	
HM4SP06	16	5/8	
HM4SP07	20	3/4	
HM4SP08	25	1	

Code	DN	Poll	Price in €
Rapisarda 4SP	10	3/8	
RAP 4SP			

7

address: ul Z. Kodályya 764/37
924 00 Galanta
Slovak republic

IČO: 36267091
IČ DPH: SK 2021917766
Account No.: 2629090057/1100
Skype: hydratech.s.r.o

tel:+421 31 780 42 46
fax:+421 31 780 42 45
email: office@hydratech-slovakia.eu
http: www.hydratech-slovakia.eu

Spoločnosť je zapísaná v Obchodnom registri Okresného súdu Trnava, oddiel Sro, vložka č. 15610/T
The company is signed in the Companies register of The District Court Trnava, section Sro, insert No: 15610/T

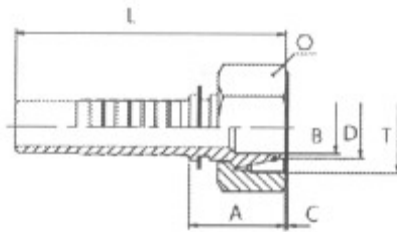
DKOL Female

Code	Hose I.D.		Thread	Dimensions					Price in €
	DN	Poll		T	L	A	C	B	
DKOL0312	5	3/16	M 12x1,5	50,5	25	2	3,2	14	
DKOL0314	5	3/16	M 14x1,5	51,5	26	2	4	17	
DKOL0412	6	1/4	M 12x1,5	49	20,5	2	4	17	
DKOL0414	6	1/4	M 14x1,5	54,5	26	2	4	17	
DKOL0416	6	1/4	M 16x1,5	55	26,5	3	5,5	19	
DKOL0418	6	1/4	M 18x1,5	55	26,5	3	7	22	
DKOL0516	8	5/16	M 16x1,5	55	26,5	3	5,5	19	

BSP DKR Female

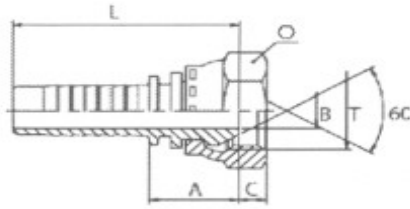

Code	Hose I.D.		Thread	Dimensions					Price in €
	DN	Poll		T	L	A	C	B	
DKR0302	5	3/16	1/8	44	18	3	4	14	
DKR0304	5	3/16	1/4	44	18	5	5	19	
DKR0402	6	1/4	1/8	47	18	3	4	14	
DKR0404	6	1/4	1/4	47	18	5	5	19	
DKR0406	6	1/4	3/8	48	20	7	7,5	22	
DKR0408	6	1/4	1/2	50	22	7	10	27	
DKR0504	8	5/16	1/4	47	18	5	5,5	19	
DKR0506	8	5/16	3/8	48	20	7	7,5	22	
DKR0508	8	5/16	1/2	50	22	7	10	27	
DKR0604	10	3/8	1/4	48	18	5	5	19	
DKR0606	10	3/8	3/8	50	20	7	7,5	22	
DKR0608	10	3/8	1/2	52	22	7	10	27	
DKR0806	12	1/2	3/8	54	21	7	7,5	22	
DKR0808	12	1/2	1/2	56	23	7	10	27	
DKR0810	12	1/2	5/8	56	23	9	12,5	28	
DKR0812	12	1/2	3/4	58	25	9	15	32	
DKR1008	16	5/8	1/2	59	23	7	10	27	
DKR1010	16	5/8	5/8	59	23	9	12,5	28	
DKR1012	16	5/8	3/4	61	25	9	15	32	
DKR1212	20	3/4	3/4	67	26	9	15	32	
DKR1216	20	3/4	1	67	26	10	21	38	
DKR1616	25	1	1	82	27	10	21	38	
DKR1620	25	1	1.1/4	85	30	11	27	50	
DKR2020	32	1.1/4	1.1/4	91	30	11	27	50	
DKR2024	32	1.1/4	1.1/2	95	34	11	33	55	
DKR2424	40	1.1/2	1.1/2	106	35	11	33	55	
DKR2432	40	1.1/2	2	107	36	15	44	70	
DKR3232	50	2	2	112	36	15	44	70	

Explanations:

DKR/BSP	DKR female 60° cone BSP
DN	Diameter in mm
Poll	Diameter in „inch“
T	Thread
L,A,C,B	Dimensions according to the picture in mm
○	Spanner

45° BSP DKR Swept Elbow

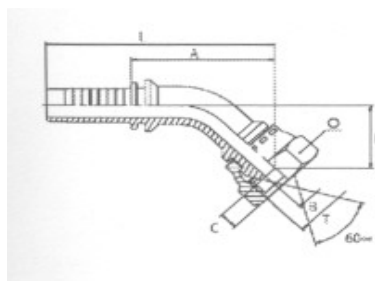

Code	Hose I.D.		Thread	Dimensions					Price in €
	DN	Poll		T	L	A	C	B	
DKR450302	5	3/16	1/8	60	34	3	4	14	
DKR450304	5	3/16	1/4	60	34	5	5	19	
DKR450404	6	1/4	1/4	65	36	5	5	19	
DKR450406	6	1/4	3/8	66	37,5	7	7,5	22	
DKR450506	8	5/16	3/8	72,5	44	7	7,5	22	
DKR450606	10	3/8	3/8	78,5	48	7	7,5	22	
DKR450608	10	3/8	1/2	80	49,5	7	10	27	
DKR450808	12	1/2	1/2	91,5	58,5	7	10	27	
DKR450810	12	1/2	5/8	91,5	58,5	9	12,5	28	
DKR451010	16	5/8	5/8	103	66,5	9	12,5	28	
DKR451012	16	5/8	3/4	104	68	9	15	32	
DKR451212	20	3/4	3/4	106	66	9	15	32	
DKR451216	20	3/4	1	110,5	69,5	10,4	21	38	
DKR451616	25	1	1	136,5	81,5	10,4	21	38	
DKR451620	25	1	1.1/4	140,5	85,5	11	27	50	
DKR452020	32	1.1/4	1.1/4	160,5	99,5	11	27	50	
DKR452024	32	1.1/4	1.1/2	166,4	105,4	10,2	33	55	
DKR452424	40	1.1/2	1.1/2	187,3	116,8	10,2	33	55	
DKR452432	40	1.1/2	2	192,6	122,1	14,6	44	70	
DKR453232	50	2	2	224	148	14,6	44	70	

Explanations:

DKR/BSP	DKR 45° Swept Elbow BSP
DN	Diameter in mm
Poll	Diameter in „inch“
T	Thread
L,A,C,B	Dimensions according to the picture in mm
○	Spanner

Comments:

10

address: ul Z. Kodályya 764/37
924 00 Galanta
Slovak republic

IČO: 36267091
IČ DPH: SK 2021917766
Account No.: 2629090057/1100
Skype: hydratech.s.r.o

tel:+421 31 780 42 46
fax:+421 31 780 42 45
email: office@hydratech-slovakia.eu
http: www.hydratech-slovakia.eu

Spoločnosť je zapísaná v Obchodnom registri Okresného súdu Trnava, oddiel Sro, vložka č. 15610/T
The company is signed in the Companies register of The District Court Trnava, section Sro, insert No: 15610/T

90° BSP DKR Swept Elbow

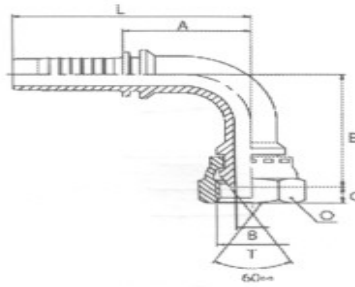

Code	Hose I.D.		Thread	Dimensions					Price in €
	DN	Poll		T	L	A	C	B	
DKR900302	5	3/16	1/8	46	21	3	4	14	
DKR900304	5	3/16	1/4	46	21	5	5	19	
DKR900404	6	1/4	1/4	52	23	5	5	19	
DKR900406	6	1/4	3/8	52	23	7	7,5	22	
DKR900506	8	5/16	3/8	57,5	29	7	7,5	22	
DKR900606	10	3/8	3/8	63,5	33	7	7,5	22	
DKR900608	10	3/8	1/2	63,5	33	7	10	27	
DKR900808	12	1/2	1/2	72,5	39,5	7	10	27	
DKR900810	12	1/2	5/8	72,5	39,5	9	12,5	28	
DKR901010	16	5/8	5/8	83,5	47,5	9	12,5	28	
DKR901012	16	5/8	3/4	82,3	47,5	9	15	32	
DKR901212	20	3/4	3/4	96,5	55,5	9	15	32	
DKR901216	20	3/4	1	96,5	55,5	10,4	21	38	
DKR901616	25	1	1	127,5	72,5	10,4	21	38	
DKR901620	25	1	1.1/4	127,5	72,5	11	27	50	
DKR902020	32	1.1/4	1.1/4	150,5	89,5	11	27	50	
DKR902024	32	1.1/4	1.1/2	150,5	89,4	10,2	33	55	
DKR902424	40	1.1/2	1.1/2	175,5	105	10,2	33	55	
DKR902432	40	1.1/2	2	175,5	105	14,6	44	70	
DKR903232	50	2	2	231	137	14,6	44	70	

Explanations:

DKR/BSP	DKR 90° Swept Elbow BSP
DN	Diameter in mm
Poll	Diameter in „inch“
T	Thread
L,A,C,B	Dimensions according to the picture in mm
○	Spanner

Comments:

90° DKR Compact Elbow

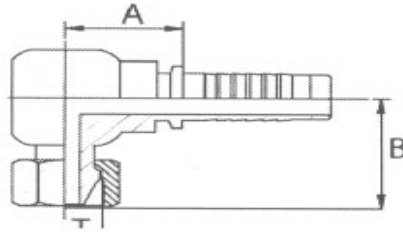

Code	Hose I.D.		Thread	Dimensions					Price in €
	DN	Poll		T	L	A	C	B	
DKR90CE0302	5	3/16	1/8-28	-	11	-	15	14	
DKR90CE0404	6	1/4	1/4-19	-	14	-	20	19	
DKR90CE0606	10	3/8	3/8-19	-	18	-	23	22	
DKR90CE0808	12	1/2	1/2-14	-	21	-	23	27	
DKR90CE1212	20	3/4	3/8-14	-	27	-	31	32	
DKR90CE1616	25	1	1-11	-	35	-	35	38	

Explanations:

DKR90CE	DKR 90° Compact Elbow 60° cone
DN	Diameter in mm
Poll	Diameter in „inch“
T	Thread
A,B	Dimensions according to the picture in mm
○	Spanner

Comments:

„Nissan” DKR BSP Double Hexagon



Code	Hose I.D.		Thread	Dimensions					Price in €
	DN	Poll		T	L	A	C	o ¹	
DKRDHEX04	6	1/4	1/4	-	-	-	19	17	
DKRDHEX06	10	3/8	3/8	-	-	-	22	19	
DKRDHEX08	12	1/2	1/2	-	-	-	27	22	
DKRDHEX12	20	3/4	3/4	-	-	-	32	27	
DKRDHEX16	25	1	1	-	-	-	41	32	

Explanations:

DKRDHEX/
BSP Nissan DKR Double Hexagon 60° cone
DN Diameter in mm
Poll Diameter in „inch“
T Thread
o¹, o² Spanner 1, Spanner 2

Comments:

BSP AGR Male

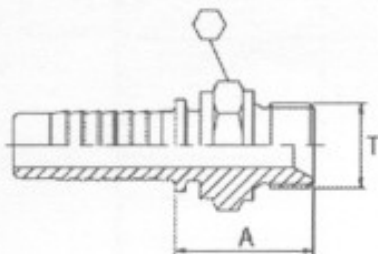

Code	Hose I.D.		Thread	Dimensions					Price in €
	DN	Poll		L	A	C	B	o	
AGR/BSP	DN	Poll	T	L	A	C	B	o	
AGR0302	5	3/16	1/8	-	18,5	-	-	14	
AGR0304	5	3/16	1/4	-	24	-	-	19	
AGR0402	6	1/4	1/8	-	21,5	-	-	14	
AGR0404	6	1/4	1/4	-	27	-	-	19	
AGR0406	6	1/4	3/8	-	28,5	-	-	22	
AGR0504	8	5/16	1/4	-	27	-	-	19	
AGR0506	8	5/16	3/8	-	28,5	-	-	22	
AGR0508	8	5/16	1/2	-	34,5	-	-	27	
AGR0604	10	3/8	1/4	-	27,5	-	-	19	
AGR0606	10	3/8	3/8	-	29	-	-	22	
AGR0608	10	3/8	1/2	-	32,5	-	-	27	
AGR0806	12	1/2	3/8	-	29,5	-	-	22	
AGR0808	12	1/2	1/2	-	33	-	-	27	
AGR0810	12	1/2	5/8	-	34,5	-	-	28	
AGR0812	12	1/2	3/4	-	35,5	-	-	32	
AGR1008	16	5/8	1/2	-	33	-	-	27	
AGR1010	16	5/8	5/8	-	33	-	-	28	
AGR1012	16	5/8	3/4	-	34,5	-	-	32	
AGR1212	20	3/4	3/4	-	36	-	-	32	
AGR1216	20	3/4	1	-	38,5	-	-	38	
AGR1616	25	1	1	-	39,5	-	-	38	
AGR1620	25	1	1.1/4	-	42,5	-	-	50	
AGR2020	32	1.1/4	1.1/4	-	42,5	-	-	50	
AGR2024	32	1.1/4	1.1/2	-	44,5	-	-	55	
AGR2424	40	1.1/2	1.1/2	-	46	-	-	55	
AGR2432	40	1.1/2	2	-	50	-	-	70	
AGR3232	50	2	2	-	52,5	-	-	70	

Explanations:

AGR/BSP	AGR BSP Male 60° cone
DN	Diameter in mm
Poll	Diameter in „inch“
T	Thread
A,	Dimensions according to the picture in mm
o	Spanner

AGN NPTF Male

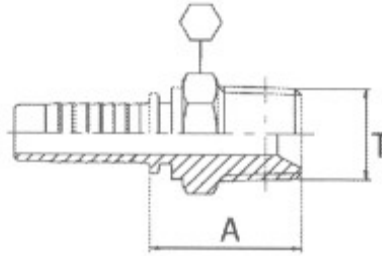

Code	Hose I.D.		Thread	Dimensions					Price in €
	DN	Poll		T	L	A	C	B	
AGN0302	5	3/16	1/8-27	-	23	-	-	12	
AGN0304	5	3/16	1/4-18	-	27	-	-	17	
AGN0402	6	1/4	1/8-27	-	26,5	-	-	12	
AGN0404	6	1/4	1/4-18	-	27	-	-	17	
AGN0406	6	1/4	3/8-18	-	28	-	-	19	
AGN0504	8	5/16	1/4-18	-	27	-	-	17	
AGN0506	8	5/16	3/8-18	-	28	-	-	19	
AGN0604	10	3/8	1/4-18	-	27	-	-	17	
AGN0606	10	3/8	3/8-18	-	28	-	-	19	
AGN0608	10	3/8	1/2-14	-	34	-	-	22	
AGN0806	12	1/2	3/8-18	-	26	-	-	19	
AGN0808	12	1/2	1/2-14	-	31,5	-	-	22	
AGN1012	16	5/8	3/4-14	-	33	-	-	30	
AGN1212	20	3/4	3/4-14	-	36,5	-	-	30	
AGN1216	20	3/4	1-11.1/2	-	42,5	-	-	36	
AGN1616	25	1	1-11.1/2	-	43,5	-	-	36	
AGN2020	32	1.1/4	1.1/4-11.1/2	-	46	-	-	46	
AGN2424	40	1.1/2	1.1/2-11.1/2	-	49	-	-	50	
AGN3232	50	2	2-11.1/2	-	51	-	-	65	

Explanations:

AGN/NPTF	AGN NPTF Male 60° cone
DN	Diameter in mm
Poll	Diameter in „inch“
T	Thread
A,	Dimensions according to the picture in mm
○	Spanner

Comments:

DKJ Straight Female

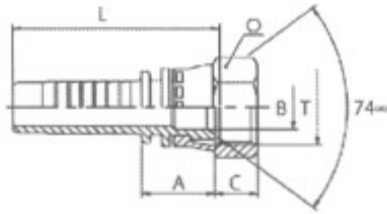

Code	Hose I.D.		Thread	Dimensions					Price in €
	DKJ	DN		Poll	T	L	A	C	
DKJ0304	5	3/16	7/16-20	40	14,5	7	5	15	
DKJ0305	5	3/16	1/2-20	42	16	9,5	5,5	17	
DKJ0404	6	1/4	7/16-20	43	14,5	9	4	15	
DKJ0405	6	1/4	1/2-20	45	16,5	9,5	5,5	17	
DKJ0406	6	1/4	9/16-18	45	16,5	10	7	19	
DKJ0505	8	5/16	1/2-20	45	16,5	10	5,5	17	
DKJ0506	8	5/16	9/16-18	45	16,5	11	7	19	
DKJ0508	8	5/16	3/4-16	47,5	19	10	10	24	
DKJ0606	10	3/8	9/16-18	47	16,5	11	7	19	
DKJ0608	10	3/8	3/4-16	48,5	19	13	10	24	
DKJ0808	12	1/2	3/4-16	53	20	11	10	24	
DKJ0810	12	1/2	7/8-14	54,5	21,5	13	12	27	
DKJ0812	12	1/2	1.1/16-12	56	23	14,5	15	32	
DKJ1010	16	5/8	7/8-14	57,5	21,5	13	12	27	
DKJ1012	16	5/8	1.1/16-12	59	23	14,5	15	32	
DKJ1212	20	3/4	1.1/16-12	65	24	14,5	15	32	
DKJ1214	20	3/4	1.3/16-12	65,5	24,5	15	18	36	
DKJ1216	20	3/4	1.5/16-12	66	25	15,5	21	41	
DKJ1616	25	1	1.5/16-12	81	26	15,5	21	41	
DKJ1620	25	1	1.5/8-12	82,5	27,5	16	27,5	50	
DKJ2020	32	1.1/4	1.5/8-12	89	28	16	27,5	50	
DKJ2024	32	1.1/4	1.7/8-12	91,5	30,5	18,5	32	55	
DKJ2424	40	1.1/2	1.7/8-12	102	31,5	18,5	32	55	
DKJ3232	50	2	2.1/2-12	109,5	33,5	28	44	70	

Explanations:

DKJ	DKJ JIC Straight Female 74° cone – Crimped Nut
DN	Diameter in mm
Poll	Diameter in „inch“
T	Thread
A,C,B	Dimensions according to the picture in mm
○	Spanner

Comments:

45° DKJ Swept Elbow

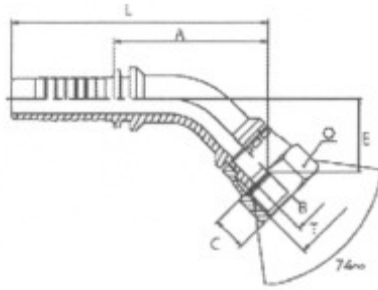

Code	Hose I.D.		Thread	Dimensions					Price in €
	DN	Poll		T	L	A	C	B	
DKJ450304	5	3/16	7/16-20	61	33	9	4	15	
DKJ450404	6	1/4	7/16-20	62	34	9	4	15	
DKJ450405	6	1/4	1/2-20	64	35	9,5	5,5	17	
DKJ450406	6	1/4	9/16-18	64	35	10	7	19	
DKJ450505	8	5/16	1/2-20	70	42	9,5	5,5	17	
DKJ450506	8	5/16	9/16-18	70	42	10	7	19	
DKJ450606	10	3/8	9/16-18	74	43	10	7	19	
DKJ450608	10	3/8	3/4-16	78	47	11	10	24	
DKJ450808	12	1/2	3/4-16	89	52	11	10	24	
DKJ450810	12	1/2	7/8-14	90	57	13	12	27	
DKJ451010	16	5/8	7/8-14	102	66	13	12	27	
DKJ451012	16	5/8	1.1/16-12	103	67	14,5	15	32	
DKJ451212	20	3/4	1.1/16-12	105	64	14,5	15	32	
DKJ451214	20	3/4	1.3/16-12	107	66	15	18	36	
DKJ451216	20	3/4	1.5/16-12	108	67	15,5	21	41	
DKJ451616	25	1	1.5/16-12	136	81	15,5	21	41	
DKJ451620	25	1	1.5/8-12	139	84	16	27,5	50	
DKJ452020	32	1.1/4	1.5/8-12	160	98	16	27,5	50	
DKJ452424	40	1.1/2	1.7/8-12	185	114	18,5	32	55	
DKJ453232	50	2	2.1/2-12	222	146	26	44	70	

Explanations:

DKJ45	45° DKJ JIC Swept Elbow 74° cone – Crimped Nut
DN	Diameter in mm
Poll	Diameter in „inch“
T	Thread
A,C,B	Dimensions according to the picture in mm
○	Spanner

Comments:

90° DKJ Swept Elbow

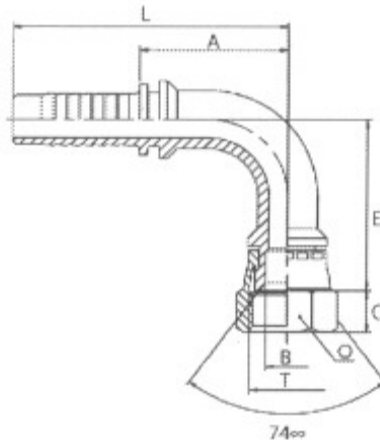

Code	Hose I.D.		Thread	Dimensions					Price in €
	DN	Poll		L	A	C	B	○	
DKJ90	DN	Poll	T	L	A	C	B	○	
DKJ900304	5	3/16	7/16-20	51	25	9	4	15	
DKJ900404	6	1/4	7/16-20	52	23	9	4	15	
DKJ900405	6	1/4	1/2-20	52	23	9,5	5,5	17	
DKJ900406	6	1/4	9/16-18	52	23	10	7	19	
DKJ900505	8	5/16	1/2-20	58	29	9,5	5,5	17	
DKJ900506	8	5/16	9/16-18	58	29	10	7	19	
DKJ900606	10	3/8	9/16-18	60	29	10	7	19	
DKJ900608	10	3/8	3/4-16	64	33	11	10	24	
DKJ900808	12	1/2	3/4-16	73	40	11	10	24	
DKJ900810	12	1/2	7/8-14	73	40	13	12	27	
DKJ901010	16	5/8	7/8-14	84	48	13	12	27	
DKJ901012	16	5/8	1.1/16-12	84	48	14,5	15	32	
DKJ901212	20	3/4	1.1/16-12	97	56	14,5	15	32	
DKJ901214	20	3/4	1.3/16-12	97	56	15	18	36	
DKJ901216	20	3/4	1.5/16-12	97	56	15,5	21	41	
DKJ901616	25	1	1.5/16-12	128	73	15,5	21	41	
DKJ901620	25	1	1.5/8-12	128	73	16	27,5	50	
DKJ902020	32	1.1/4	1.5/8-12	150	89	16	27,5	50	
DKJ902424	40	1.1/2	1.7/8-12	175	105	18,5	32	55	
DKJ903232	50	2	2.1/2-12	213	137	26	44	70	

Explanations:

DKJ45	90° DKJ JIC Swept Elbow 74° cone – Crimped Nut
DN	Diameter in mm
Poll	Diameter in „inch“
T	Thread
A,C,B	Dimensions according to the picture in mm
○	Spanner

Comments:

18

address: ul Z. Kodályya 764/37
924 00 Galanta
Slovak republic

IČO: 36267091
IČ DPH: SK 2021917766
Account No.: 2629090057/1100
Skype: hydratech.s.r.o

tel:+421 31 780 42 46
fax:+421 31 780 42 45
email: office@hydratech-slovakia.eu
<http://www.hydratech-slovakia.eu>

Spoločnosť je zapísaná v Obchodnom registri Okresného súdu Trnava, oddiel Sro, vložka č. 15610/T
The company is signed in the Companies register of The District Court Trnava, section Sro, insert No: 15610/T

AGJ Male

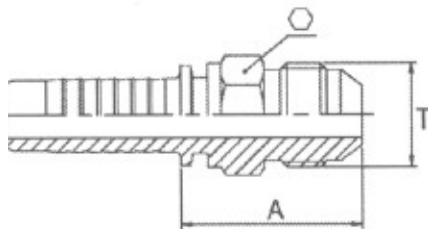

Code	Hose I.D.		Thread	Dimensions					Price in €
	DN	Poll		T	L	A	C	B	
AGJ0304	5	3/16	1/8-27	-	23	-	-	12	
AGJ0404	6	1/4	7/16-20	-	27,5	-	-	12	
AGJ0405	6	1/4	1/2-20	-	29	-	-	14	
AGJ0406	6	1/4	9/16-18	-	29	-	-	15	
AGJ0505	8	5/16	1/2-20	-	-	-	-	-	
AGJ0506	8	5/16	9/16-18	-	29	-	-	15	
AGJ0508	8	5/16	3/4-16	-	-	-	-	-	
AGJ0606	10	3/8	9/16-18	-	28,5	-	-	15	
AGJ0608	10	3/8	3/4-16	-	33	-	-	19	
AGJ0610	10	3/8	7/8-14	-	35,5	-	-	24	
AGJ0808	12	1/2	3/4-16	-	33,5	-	-	19	
AGJ0810	12	1/2	7/8-14	-	36,5	-	-	24	
AGJ0812	12	1/2	1.1/16-12	-	40	-	-	27	
AGJ1010	16	5/8	7/8-14	-	36	-	-	24	
AGJ1012	16	5/8	1.1/16-12	-	39,5	-	-	27	
AGJ1212	20	3/4	1.1/16-12	-	40,5	-	-	27	
AGJ1214	20	3/4	1.3/16-12	-	42,5	-	-	32	
AGJ1216	20	3/4	1.5/16-12	-	43	-	-	34	
AGJ1616	25	1	1.5/16-12	-	45	-	-	34	
AGJ1620	25	1	1.5/8-12	-	48,5	-	-	42	
AGJ2020	32	1.1/4	1.5/8-12	-	48	-	-	42	
AGJ2024	32	1.1/4	1.7/8-12	-	50	-	-	50	
AGJ2424	40	1.1/2	1.7/8-12	-	54	-	-	50	
AGJ3232	50	2	2.1/2-12	-	51,5	-	-	60	

Explanations:

AGJ	AGJ JIC Male – 74° cone
DN	Diameter in mm
Poll	Diameter in „inch“
T	Thread
A,	Dimensions according to the picture in mm
o	Spanner

Comments:

19

address: ul Z. Kodályya 764/37
924 00 Galanta
Slovak republic

IČO: 36267091
IČ DPH: SK 2021917766
Account No.: 2629090057/1100
Skype: hydratech.s.r.o

tel:+421 31 780 42 46
fax:+421 31 780 42 45
email: office@hydratech-slovakia.eu
http: www.hydratech-slovakia.eu

Spoločnosť je zapísaná v Obchodnom registri Okresného súdu Trnava, oddiel Sro, vložka č. 15610/T
The company is signed in the Companies register of The District Court Trnava, section Sro, insert No: 15610/T

BSP Banjo Eye Nipple

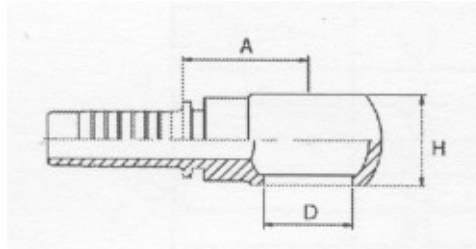

Code	Hose I.D.		Thread	Dimensions			Price in €
	DN	Poll		A	H	D	
BEN/BSP	DN	Poll	T	A	H	D	
BEN0302	5	3/16	1/8	18,9	10	10,1	
BEN0304	5	3/16	1/4	20,9	14	13,2	
BEN0402	6	1/4	1/8	22,5	10	10,1	
BEN0404	6	1/4	1/4	21,5	14	13,2	
BEN0406	6	1/4	3/8	24,5	17	16,7	
BEN0408	6	1/4	1/2	29,5	22	21,1	
BEN0504	8	5/16	1/4	21,5	14	13,2	
BEN0506	8	5/16	3/8	24,5	17	16,7	
BEN0508	8	5/16	1/2	29,5	22	21,1	
BEN0604	10	3/8	1/4	28	14	13,2	
BEN0606	10	3/8	3/8	24,5	17	16,7	
BEN0608	10	3/8	1/2	29,5	22	21,1	
BEN0806	12	1/2	3/8	27	20	16,7	
BEN0808	12	1/2	1/2	30	22	21,1	
BEN0810	12	1/2	5/8	27,5	24	23	
BEN0812	12	1/2	3/4	27,5	30	26,5	
BEN1010	16	5/8	5/8	30	24	23	
BEN1012	16	5/8	3/4	35	30	26,5	
BEN1212	20	3/4	3/4	35,5	30	26,5	
BEN1616	25	1	1	41,5	34	33,3	

Explanations:

BEN/BSP	Banjo Eye Nipple BSP
DN	Diameter in mm
Poll	Diameter in „inch“
T	Thread
A,H,D	Dimensions according to the picture in mm

Comments:

20

address: ul Z. Kodályya 764/37
924 00 Galanta
Slovak republic

IČO: 36267091
IČ DPH: SK 2021917766
Account No.: 2629090057/1100
Skype: hydratech.s.r.o

tel:+421 31 780 42 46
fax:+421 31 780 42 45
email: office@hydratech-slovakia.eu
http: www.hydratech-slovakia.eu

Spoločnosť je zapísaná v Obchodnom registri Okresného súdu Trnava, oddiel Sro, vložka č. 15610/T
The company is signed in the Companies register of The District Court Trnava, section Sro, insert No: 15610/T

BSP Connecting Nipples

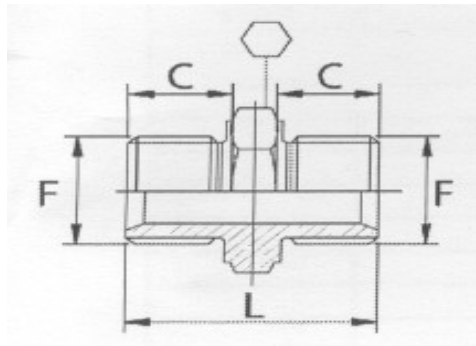

Code	Hose I.D.		Thread	Dimensions			Price in €
	DN	Poll		F	C	L	
CN02	-	-	1/8	9,5	25	14	
CN04	-	-	1/4	11	29	19	
CN06	-	-	3/8	13	33	22	
CN08	-	-	1/2	15	38	27	
CN10	-	-	5/8	15	38	27	
CN12	-	-	3/4	17	43	32	
CN16	-	-	1	19,5	49	41	
CN20	-	-	1.1/4	21	53	50	
CN24	-	-	1.1/2	22	56	55	
CN32	-	-	2	23	59	70	

Explanations:

CN/BSP Connecting Nipples BSP adapter
 ○ Spanner
F Thread
C,L Dimensions according to the picture in mm

Comments:

BSP Perfored Bolt

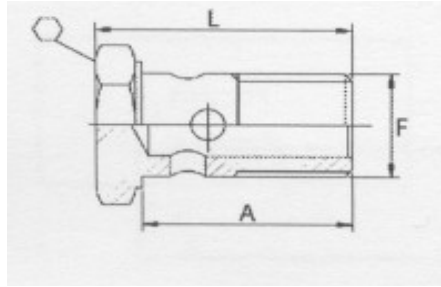

Code	Hose I.D.		Thread	Dimensions			Price in €
	DN	Poll		F	L	A	
PB02	-	-	1/8	24	19	14	
PB04	-	-	1/4	32	25	19	
PB06	-	-	3/8	38	31	22	
PB08	-	-	1/2	46	38	27	
PB10	-	-	5/8	49	41	30	
PB12	-	-	3/4	56	46	32	
PB16	-	-	1	69	58	41	

BSP Double Perfored Bolt

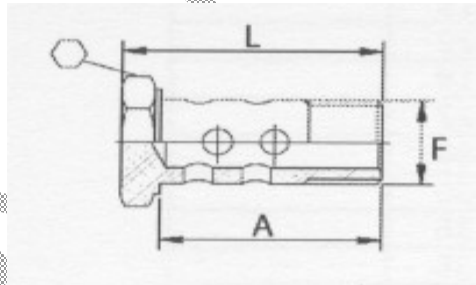

Code	Hose I.D.		Thread	Dimensions			Price in €
	DN	Poll		F	L	A	
PBD02	-	-	1/8	38	33	14	
PBD04	-	-	1/4	49	43	19	
PBD06	-	-	3/8	58	51	22	
PBD08	-	-	1/2	71	63	27	
PBD12	-	-	3/4	90	90	32	

Explanations:

- PB/BSP** BSP Perfored Bolt
- PBD/BSP** BSP Double Perfored Bolt
- F** Thread
- Spanner
- L,A** Dimensions according to the picture in mm

ORFS Straight Female

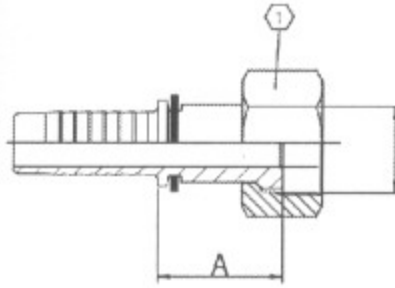

Code	Hose I.D.		Thread	Dimensions			Price in €
	DN	Poll		L	A	○	
ORFS0404	6	1/4	9/16-18	-	21	17	
ORFS0406	6	1/4	11/16-16	-	23	22	
ORFS0506	8	5/16	11/16-16	-	23	22	
ORFS0606	10	3/8	11/16-16	-	23	22	
ORFS0608	10	3/8	13/16-16	-	26	24	
ORFS0808	12	1/2	13/16-16	-	26,5	24	
ORFS0810	12	1/2	1-14	-	30	30	
ORFS0812	12	1/2	1.3/16-12	-	33	36	
ORFS1010	16	5/8	1-14	-	30	30	
ORFS1012	16	5/8	1.3/16-12	-	33	36	
ORFS1212	20	3/4	1.3/16-12	-	33,5	36	
ORFS1216	20	3/4	1.7/16-12	-	34,5	41	
ORFS1616	25	1	1.7/16-12	-	35,5	41	
ORFS2020	32	1.1/4	1.11/16-12	-	36	50	
ORFS2424	40	1.1/2	2-12	-	36,5	60	

Explanations:

ORFS ORFS Straight Female – Slip – on Nut
 ○ Spanner
T Thread
A Dimension according to the picture in mm

Comments:

23

address: ul Z. Kodály 764/37
924 00 Galanta
Slovak republic

IČO: 36267091
IČ DPH: SK 2021917766
Account No.: 2629090057/1100
Skype: hydratech.s.r.o

tel:+421 31 780 42 46
fax:+421 31 780 42 45
email: office@hydratech-slovakia.eu
http: www.hydratech-slovakia.eu

Spoločnosť je zapísaná v Obchodnom registri Okresného súdu Trnava, oddiel Sro, vložka č. 15610/T
The company is signed in the Companies register of The District Court Trnava, section Sro, insert No: 15610/T

ORFS 45° Swept Elbow

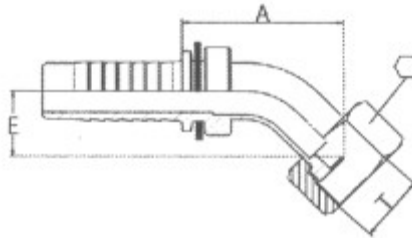

Code	Hose I.D.		Thread	Dimensions			Price in €
	DN	Poll		L	A	o	
ORFS45	DN	Poll	T				
ORFS450404	6	1/4	9/16-18	-	35,5	17	
ORFS450406	6	1/4	11/16-16	-	37	22	
ORFS450506	8	5/16	11/16-16	-	44,5	22	
ORFS450606	10	3/8	11/16-16	-	48,5	22	
ORFS450608	10	3/8	13/16-16	-	51	24	
ORFS450608	10	3/8	13/16-16	-	51	24	
ORFS450808	12	1/2	13/16-16	-	58	24	
ORFS450810	12	1/2	1-14	-	60	30	
ORFS450812	12	1/2	1.3/16-12	-	62,5	36	
ORFS451010	16	5/8	1-14	-	73,5	30	
ORFS451012	16	5/8	1.3/16-12	-	75,5	36	
ORFS451212	20	3/4	1.3/16-12	-	82,5	36	
ORFS451216	20	3/4	1.7/16-12	-	85,5	41	
ORFS451616	25	1	1.7/16-12	-	102	41	
ORFS452020	32	1.1/4	1.11/16-12	-	126	50	
ORFS452424	40	1.1/2	2-12	-	140	60	

Explanations:

ORFS45 ORFS 45° Swept Elbow – Slip – on Nut
 o Spanner
 T Thread
 A Dimension according to the picture in mm

Comments:

ORFS 90° Swept Elbow

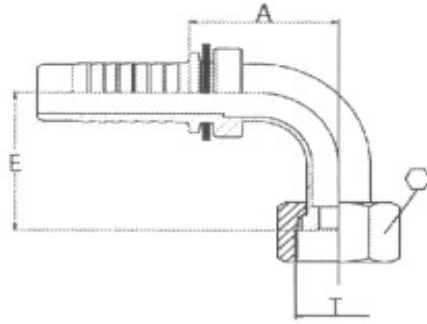

Code	Hose I.D.		Thread	Dimensions			Price in €
	DN	Poll		L	A	o	
ORFS90	DN	Poll	T	L	A	o	
ORFS900404	6	1/4	9/16-18	-	24	17	
ORFS900406	6	1/4	11/16-16	-	24	22	
ORFS900506	8	5/16	11/16-16	-	31	22	
ORFS900606	10	3/8	11/16-16	-	34	22	
ORFS900608	10	3/8	13/16-16	-	34	24	
ORFS900808	12	1/2	13/16-16	-	41	24	
ORFS900810	12	1/2	1-14	-	41	30	
ORFS900812	12	1/2	1.3/16-12	-	41	36	
ORFS901010	16	5/8	1-14	-	49	30	
ORFS901012	16	5/8	1.3/16-12	-	49	36	
ORFS901212	20	3/4	1.3/16-12	-	58	36	
ORFS901216	20	3/4	1.7/16-12	-	58	41	
ORFS901616	25	1	1.7/16-12	-	74	41	
ORFS902020	32	1.1/4	1.11/16-12	-	92	50	
ORFS902424	40	1.1/2	2-12	-	108	60	

Explanations:

ORFS45 ORFS 90° Swept Elbow – Slip – on Nut
 o Spanner
 T Thread
 A Dimension according to the picture in mm

Comments:

25

address: ul Z. Kodálya 764/37
 924 00 Galanta
 Slovak republic

IČO: 36267091
 IČ DPH: SK 2021917766
 Account No.: 2629090057/1100
 Skype: hydratech.s.r.o

tel:+421 31 780 42 46
 fax:+421 31 780 42 45
 email: office@hydratech-slovakia.eu
 http: www.hydratech-slovakia.eu

Spoločnosť je zapísaná v Obchodnom registri Okresného súdu Trnava, oddiel Sro, vložka č. 15610/T
 The company is signed in the Companies register of The District Court Trnava, section Sro, insert No: 15610/T

ORFS Male

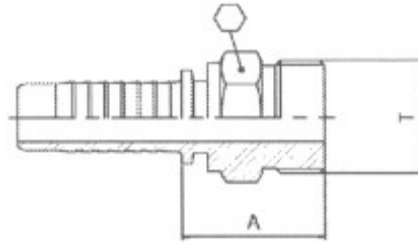

Code	Hose I.D.		Thread	Dimensions			Price in €
	DN	Poll		L	A	o	
ORFSM0404	6	1/4	9/16-18	-	23,5	17	
ORFSM0406	6	1/4	11/16-16	-	26	19	
ORFSM0506	8	5/16	11/16-16	-	26	19	
ORFSM0606	10	3/8	11/16-16	-	26	19	
ORFSM0608	10	3/8	13/16-16	-	28	22	
ORFSM0610	10	3/8	1-14	-	32,5	27	
ORFSM0808	12	1/2	13/16-16	-	29	22	
ORFSM0810	12	1/2	1-14	-	33,5	27	
ORFSM0812	12	1/2	1.3/16-12	-	35	32	
ORFSM1010	16	5/8	1-14	-	33,5	27	
ORFSM1012	16	5/8	1.3/16-12	-	35	32	
ORFSM1212	20	3/4	1.3/16-12	-	36	32	
ORFSM1216	20	3/4	1.7/16-12	-	36,5	41	
ORFSM1616	25	1	1.7/16-12	-	38	41	
ORFSM2020	32	1.1/4	1.11/16-12	-	40	46	
ORFSM2424	40	1.1/2	2-12	-	43	55	

Explanations:

ORFSM ORFS Male
o Spanner
T Thread
A Dimension according to the picture in mm

Comments:

KOMATSU

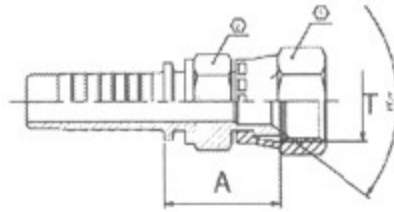

Code	Hose I.D.		Thread	Dimensions			Price in €
	DN	Poll		A	o ¹	o ²	
KOM0414	4	1/4	M14x1,5	-	19	17	
KOM0516	5	5/16	M16x1,5	-	22	20	
KOM0618	6	3/8	M18x1,5	-	24	19	
KOM0822	8	1/2	M22x1,5	-	27	22	
KOM1024	10	5/8	M24x1,5	-	30	27	
KOM1230	12	3/4	M30x1,5	-	36	30	
KOM1633	16	1	M33x1,5	-	41	36	
KOM2036	20	1.1/4	M36x1,5	-	46	46	
KOM2442	24	1.1/2	M42x1,5	-	50	50	

Explanations:

KOM Komatsu Metric Female 60° cone – Crimped Nut
 o¹ o² Spanner 1 and Spanner 2
T Thread
A Dimension according to the picture in mm

TOYOTA

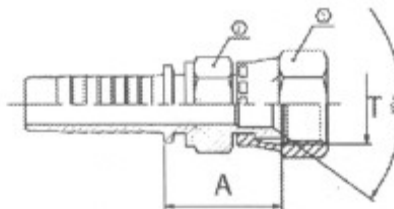

Code	Hose I.D.		Thread	L	Dimensions		Price in €
	DN	Poll			T	o ¹	
TOY0404	4	1/4	1/4	-	19	19	
TOY0606	6	3/8	3/8	-	22	22	
TOY0808	8	1/2	1/2	-	27	27	
TOY1212	12	3/4	3/4	-	32	32	
TOY1616	16	1	1	-	38	38	

Explanations:

TOYBSP Toyota BSP Female 60° cone – Crimped Nut
 o¹ o² Spanner 1 and Spanner 2
T Thread
A Dimension according to the picture in mm

Double Insert

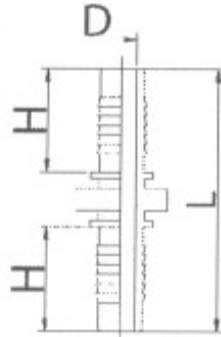

Code	Hose I.D.		Dimensions				Price in €
	DI	DN	Poll	L	H	D	
DI5904	6	1/4	85	28,5	4	-	
DI5905	8	5/16	85,5	28,5	5,5	-	
DI5906	10	3/8	91	30,5	7	-	
DI5908	12	1/2	99,5	33	9,5	-	
DI5910	16	5/8	106,5	36	12	-	
DI5912	20	3/4	120	41	14,5	-	
DI5916	25	1	152,5	55	20	-	

Explanations:

DI Double Insert
 D Diameter
 A,H Dimensions according to the picture in mm

WashCleaner Female

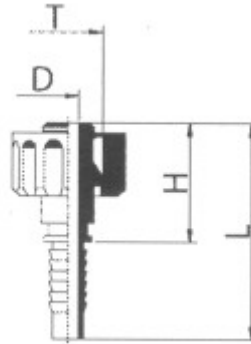

Code	Hose I.D.		Thread	Dimensions			Price in €
	WCL	DN	Poll	T	L	H	
WCL0422	6	1/4	M22x1,5	64	35,5	6,5	
WCL0522	8	5/16	M22x1,5	64	35,5	6,5	
WCL0622	10	3/8	M22x1,5	67	35,5	7	

Explanations:

WCL WashCleaner Female – FK Type
 D Diameter
 L,H Dimensions according to the picture in mm

SFL Straight Flange

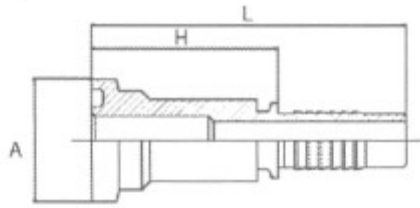

Code	Hose I.D.		Thread	Dimensions			Price in €
	DN	Poll		L	A	H	
SFL0808	12	1/2	-	81,5	30,2	48,5	
SFL0812	12	1/2	-	85,5	38,1	52,5	
SFL1212	20	3/4	-	94,5	38,1	53,5	
SFL1216	20	3/4	-	100,5	44,5	59,5	
SFL1616	25	1	-	115,5	44,5	60,5	
SFL1620	25	1	-	120	50,8	65	
SFL2020	32	1.1/4	-	126,5	50,8	65,5	
SFL2024	32	1.1/4	-	130	60,3	70	
SFL2424	40	1.1/2	-	141	60,3	70,5	
SFL2432	40	1.1/2	-	147,5	71,4	77,5	
SFL3232	50	2	-	153	71,4	77	

Explanations:

SFL SFL Straight Flange – SAE J518 – 3000 Psi
T Thread
L,A,H Dimensions according to the picture in mm

Comments:

45° SFL Flange

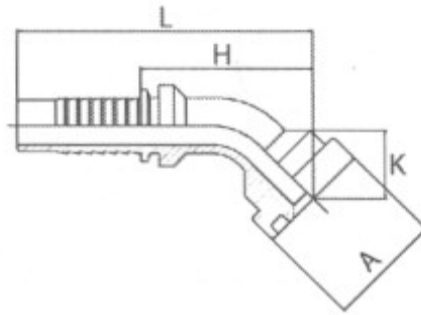

Code	Hose I.D.		Thread	Dimensions			Price in €
	DN	Poll		T	L	A	
SFL450808	12	1/2	-	89,5	30,2	56,5	
SFL450812	12	1/2	-	93	38,1	60	
SFL451212	20	3/4	-	104	38,1	63	
SFL451216	20	3/4	-	106	44,5	65	
SFL451616	25	1	-	135,5	44,5	80,5	
SFL451620	25	1	-	136,5	50,8	32,8	
SFL452020	32	1.1/4	-	159,5	50,8	98,5	
SFL452024	32	1.1/4	-	159,5	60,3	99	
SFL452424	40	1.1/2	-	186	60,3	115,5	
SFL452432	40	1.1/2	-	188	71,4	117,5	
SFL453232	50	2	-	227,5	71,4	151,5	

Explanations:

SFL45 45° SFL Flange – SAE J518 – 3000 Psi
 T Thread
 L,A,H Dimensions according to the picture in mm

Comments:

90° SFL Flange

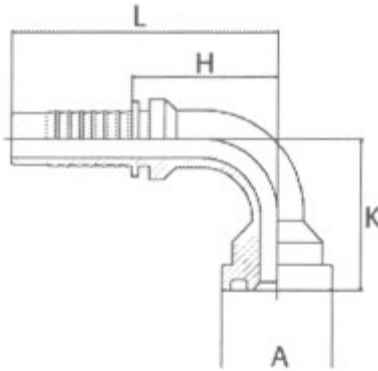

Code	Hose I.D.		Thread	Dimensions			Price in €
	DN	Poll		L	A	H	
SFL900808	12	1/2	-	72,5	30,2	39,5	
SFL900812	12	1/2	-	72,5	38,1	39,5	
SFL901212	20	3/4	-	96,5	38,1	55,5	
SFL901216	20	3/4	-	96,5	44,5	55,5	
SFL901616	25	1	-	127,5	44,5	72,5	
SFL901620	25	1	-	127,5	50,8	72,5	
SFL902020	32	1.1/4	-	150,5	50,8	89,5	
SFL902024	32	1.1/4	-	150,5	60,3	89,5	
SFL902424	40	1.1/2	-	175	60,3	105	
SFL902432	40	1.1/2	-	175	71,4	105	
SFL903232	50	2	-	213	71,4	137	

Explanations:

SFL90 90° SFL Flange – SAE J518 – 3000 Psi
 T Thread
 L,A,H Dimensions according to the picture in mm

Comments:

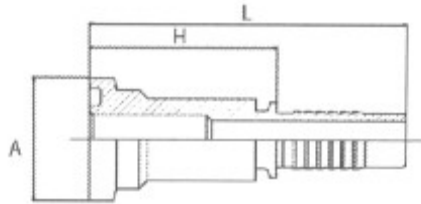
SFS Straight Flange

Code	Hose I.D.		Thread	Dimensions			Price in €
	DN	Poll		L	A	H	
SFS0808	12	1/2	-	82,5	31,7	49,5	
SFS0812	12	1/2	-	89	41,3	56	
SFS1212	20	3/4	-	101	41,3	60	
SFS1216	20	3/4	-	103,5	47,6	62,5	
SFS1616	25	1	-	121,5	47,6	66,5	
SFS1620	25	1	-	125,5	54	70,5	
SFS2020	32	1.1/4	-	132	54	71	
SFS2024	32	1.1/4	-	141	63,5	80,5	
SFS2424	40	1.1/2	-	151,5	63,5	81	
SFS2432	40	1.1/2	-	170,5	79,4	100	
SFS3232	50	2	-	176	79,4	100	

Explanations:

SFS SFS Straight Flange – SAE J518 – 6000 Psi
T Thread
L,A,H Dimensions according to the picture in mm

Comments:

45° SFS Flange

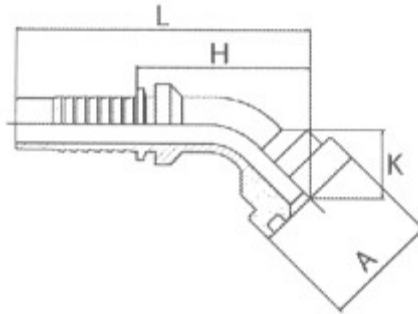

Code	Hose I.D.		Thread	Dimensions			Price in €
	DN	Poll		L	A	H	
SFS450808	12	1/2	-	90	31,7	57	
SFS450812	12	1/2	-	96	41,3	63	
SFS451212	20	3/4	-	108	41,3	66,5	
SFS451216	20	3/4	-	112	47,6	71	
SFS451616	25	1	-	140	47,6	85	
SFS451620	25	1	-	145	54	90	
SFS452020	32	1.1/4	-	162	54	101	
SFS452024	32	1.1/4	-	166	63,5	45	
SFS452424	40	1.1/2	-	186,5	63,5	116	
SFS452432	40	1.1/2	-	197,5	79,4	56,5	
SFS453232	50	2	-	229	79,4	153	

Explanations:

SFS45 45° SFS Flange – SAE J518 – 6000 Psi
 T Thread
 L,A,H Dimensions according to the picture in mm

Comments:

90° SFS Flange

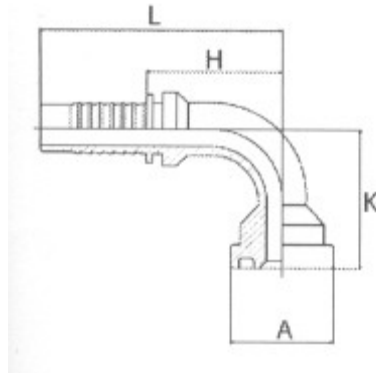

Code	Hose I.D.		Thread	Dimensions			Price in €
	DN	Poll		L	A	H	
SFS900808	12	1/2	-	72,5	31,7	39,5	
SFS900812	12	1/2	-	72,5	41,3	39,5	
SFS901212	20	3/4	-	96,5	41,3	55,5	
SFS901216	20	3/4	-	96,5	47,6	55,5	
SFS901616	25	1	-	127,5	47,6	72,5	
SFS901620	25	1	-	127,5	54	72,5	
SFS902020	32	1.1/4	-	150,5	54	89,5	
SFS902024	32	1.1/4	-	150,5	63,5	89,5	
SFS902424	40	1.1/2	-	174	63,5	104,5	
SFS902432	40	1.1/2	-	175	79,4	104,5	
SFS903232	50	2	-	213	79,4	137	

Explanations:

SFS90 90° SFS Flange – SAE J518 – 6000 Psi
 T Thread
 L,A,H Dimensions according to the picture in mm

Comments:

SFS Supercat

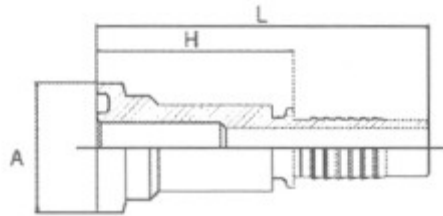

Code	Hose I.D.		Thread	Dimensions			Price in €
	DN	Poll		L	A	H	
SFSSC1212	20	3/4	-	106	41,3	65,5	
SFSSC1216	20	3/4	-	108	47,6	67,5	
SFSSC1616	25	1	-	126	47,6	71,5	
SFSSC1620	25	1	-	129,5	54	74,5	
SFSSC2020	32	1.1/4	-	136	54	75	
SFSSC2024	32	1.1/4	-	143	63,5	82	
SFSSC2424	40	1.1/2	-	153	63,5	83	

Explanations:

SFSSC SFS Straight Flange – Supercat
T Thread
L,A,H Dimensions according to the picture in mm

Comments:

45° SFS Supercat

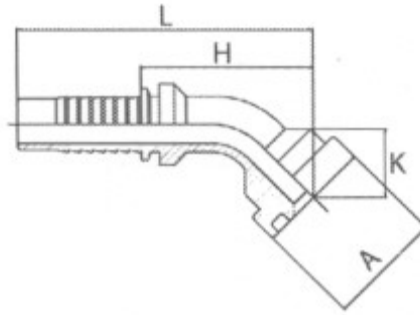

Code	Hose I.D.		Thread	Dimensions			Price in €
	DN	Poll		L	A	H	
SFSSC451212	20	3/4	-	135	41,3	94	
SFSSC451216	20	3/4	-	140	47,6	99	
SFSSC451616	25	1	-	170,5	47,6	112	
SFSSC451620	25	1	-	175	54	120	
SFSSC452020	32	1.1/4	-	202,5	54	142	
SFSSC452024	32	1.1/4	-	205,5	63,5	145	
SFSSC452424	40	1.1/2	-	234	63,5	164	

Explanations:

SFSSC45 45° SFS Flange – Supercat
 T Thread
 L,A,H Dimensions according to the picture in mm

Comments:

36

address: ul Z. Kodályya 764/37
 924 00 Galanta
 Slovak republic

IČO: 36267091
 IČ DPH: SK 2021917766
 Account No.: 2629090057/1100
 Skype: hydratech.s.r.o

tel:+421 31 780 42 46
 fax:+421 31 780 42 45
 email: office@hydratech-slovakia.eu
 http: www.hydratech-slovakia.eu

Spoločnosť je zapísaná v Obchodnom registri Okresného súdu Trnava, oddiel Sro, vložka č. 15610/T
 The company is signed in the Companies register of The District Court Trnava, section Sro, insert No: 15610/T

90° SFS – Supercat

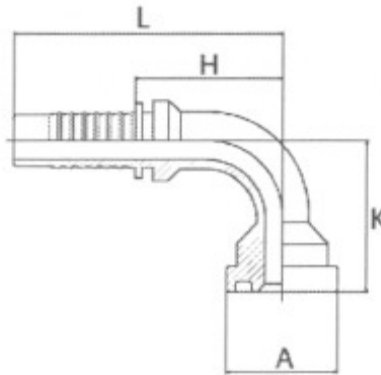

Code	Hose I.D.		Thread	Dimensions			Price in €
	DN	Poll		L	A	H	
SFSSC901212	20	3/4	-	99	41,3	58	
SFSSC901216	20	3/4	-	99	47,6	58	
SFSSC901616	25	1	-	129	47,6	74	
SFSSC901620	25	1	-	129	54	74	
SFSSC902020	32	1.1/4	-	153	54	92	
SFSSC902024	32	1.1/4	-	153	63,5	92	
SFSSC902424	40	1.1/2	-	179	63,5	108	

Explanations:

SFSSC90 90° SFS Flange – Supercat
 T Thread
 L,A,H Dimensions according to the picture in mm

Comments:

FHL

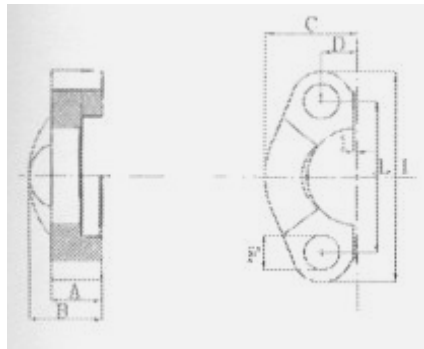

Code	Dimensions								Price in €
	FHL	Poll	I	L	D	C	F	B	
FHL08	1/2	54	38,1	8,7	23	8,75	20	13	
FHL12	3/4	65	47,6	11,1	26	10,5	22	14	
FHL16	1	70	52,4	13,1	29,2	10,5	22	16	
FHL20	1.1/4	50	58,7	15,1	36,3	12	22	14	
FHL24	1.1/2	94	69,9	17,9	41,1	13,5	24	16	
FHL32	2	102	77,8	21,4	48,2	41,1	26	16	

Explanations:

FHL FHL Split Half Flange 3000 Psi
I,L,D,C,F,B,A Dimensions according to the picture in mm

FHS

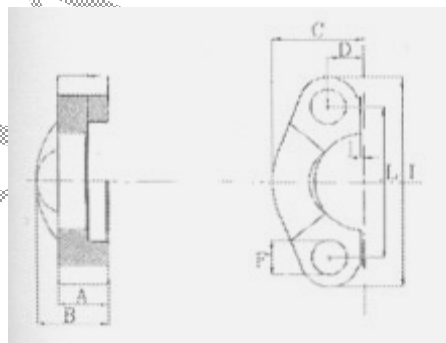

Code	Dimensions								Price in €
	FHS	Poll	I	L	D	C	F	B	
FHS08	1/2	57	40,5	9,1	24	8,75	22	16	
FHS12	3/4	72	50,8	11,9	30	10,5	28	19	
FHS16	1	81	57,2	13,9	35	13	32	24	
FHS20	1.1/4	96	66,7	15,9	39	15	38	27	
FHS24	1.1/2	113	79,4	18,3	48	17	42	30	
FHS32	2	134	96,8	22,2	57	21	52	37	

Explanations:

FHS FHS Split Half Flange 6000 Psi
I,L,D,C,F,B,A Dimensions according to the picture in mm

Metric Banjo Nipple

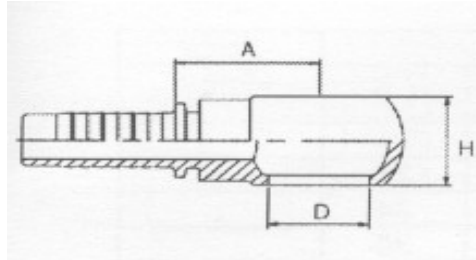

Code	Hose I.D.		Thread	Dimensions			Price in €
	DN	Poll		A	H	D	
BNM0312	5	3/16	M12x1,5	22,3	12	12,1	
BNM0314	5	3/16	M14x1,5	24,3	14	14,1	
BNM0412	6	1/4	M12x1,5	22,5	12	12,1	
BNM0414	6	1/4	M14x1,5	24,5	14	14,1	
BNM0416	6	1/4	M16x1,5	26,5	18	16,1	
BNM0418	6	1/4	M18x1,5	28,5	20	18,1	
BNM0514	8	5/16	M14x1,5	24,5	14	14,1	
BNM0516	8	5/16	M16x1,5	26,5	18	16,1	
BNM0518	8	5/16	M18x1,5	28,5	20	18,1	
BNM0614	10	3/8	M14x1,5	24,5	14	14,1	
BNM0616	10	3/8	M16x1,5	26,5	18	16,1	
BNM0618	10	3/8	M18x1,5	28,5	20	18,1	
BNM0620	10	3/8	M20x1,5	29,5	22	20,1	
BNM0622	10	3/8	M22x1,5	31,5	22	22,1	
BNM0818	12	1/2	M18x1,5	29	20	18,1	
BNM0820	12	1/2	M20x1,5	30	22	20,1	
BNM0822	12	1/2	M22x1,5	32	22	22,1	
BNM1022	16	5/8	M22x1,5	32	22	22,1	
BNM1024	16	5/8	M24x1,5	30	24	24,1	
BNM1226	20	3/4	M26x1,5	-	-	-	
BNM1230	20	3/4	M30x1,5	-	-	-	
BNM1630	25	1	M30x1,5	-	-	-	

Explanations:

BNM	Metric Banjo Nipple
DN	Diameter in mm
Poll	Diameter in „inch“
T	Thread
A,H,D	Dimensions according to the picture in mm

Comments:

Metric Bolt

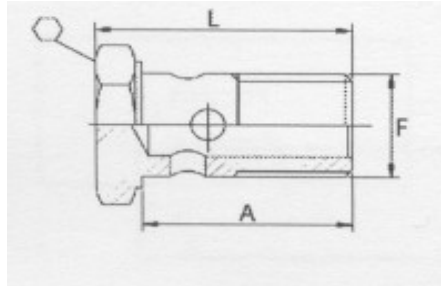

Code	Hose I.D.		Thread	Dimensions			Price in €
	DN	Poll		F	L	A	
MB06	-	-	M6x1	21	16	10	
MB08	-	-	M8x1	21	16	12	
MB10	-	-	M10x1,5	24	29	14	
MB12	-	-	M12x1,5	30	24	17	
MB14	-	-	M14x1,5	34	28	19	
MB16	-	-	M16x1,5	39	32	22	
MB18	-	-	M18x1,5	44	36	24	
MB20	-	-	M20x1,5	48	40	27	
MB22	-	-	M22x1,5	48	40	27	
MB24	-	-	M24x1,5	50	42	30	
MB26	-	-	M26x1,5	52	42	32	
MB30	-	-	M30x1,5	62	51	38	

Double Metric Bolt

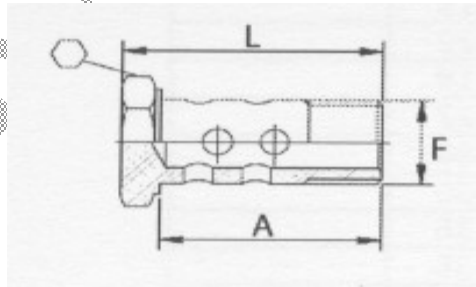

Code	Hose I.D.		Thread	Dimensions			Price in €
	DN	Poll		F	L	A	
MBD08	-	-	M8x1	34	29	12	
MBD10	-	-	M10x1	38	33	14	
MBD12	-	-	M12x1,5	43	37	17	
MBD14	-	-	M14x1,5	49	43	19	
MBD16	-	-	M16x1,5	58	51	22	
MBD18	-	-	M18x1,5	65	57	24	
MBD22	-	-	M22x1,5	71	63	27	

HYDRATECH s.r.o.

Explanations:

MB	Metric Bolt
MBD	Double Metric Bolt
F	Thread
○	Spanner
L,A	Dimensions according to the picture in mm

Comments:

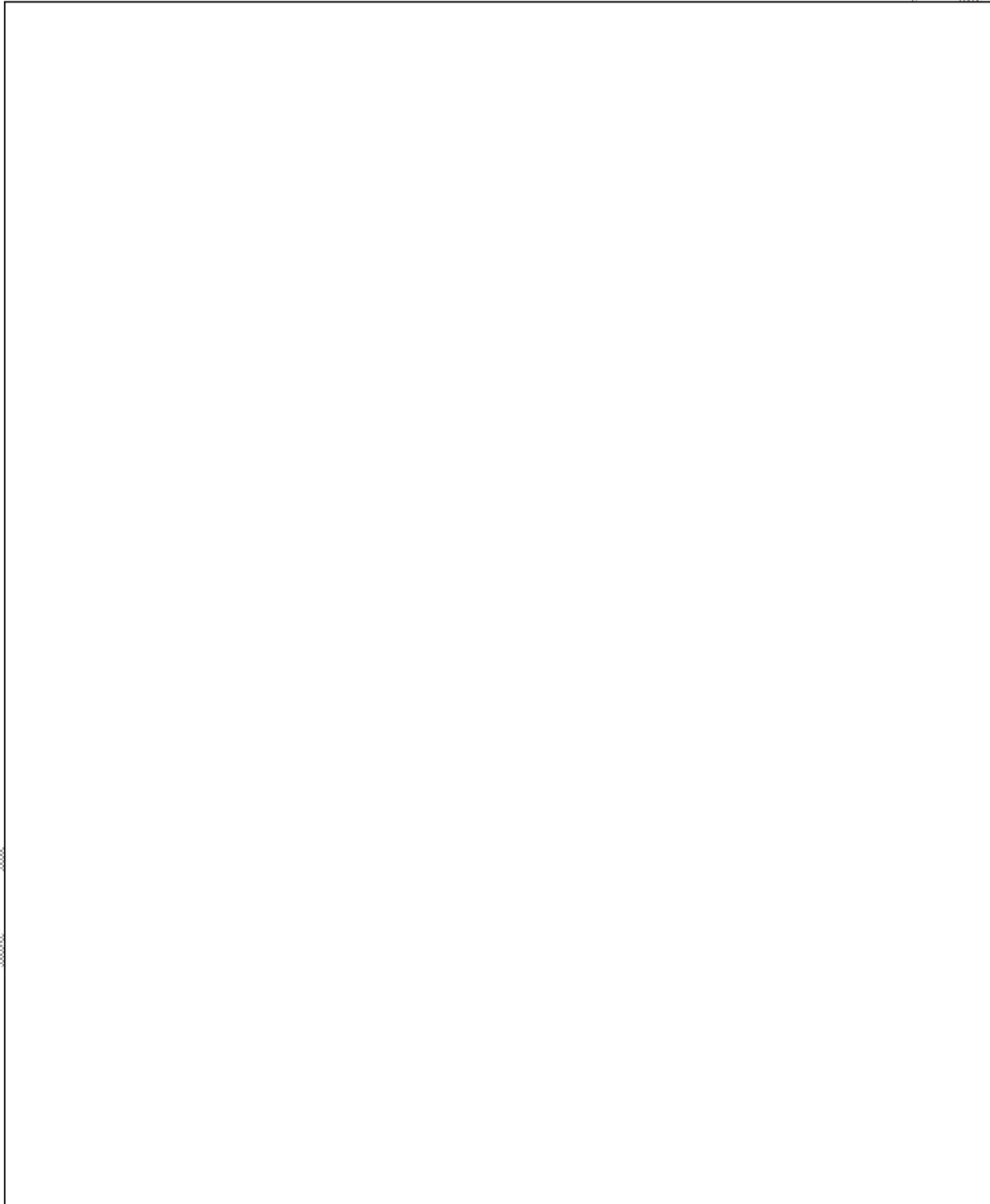

41

address: ul Z. Kodálya 764/37
924 00 Galanta
Slovak republic

IČO: 36267091
IČ DPH: SK 2021917766
Account No.: 2629090057/1100
Skype: hydratech.s.r.o

tel:+421 31 780 42 46
fax:+421 31 780 42 45
email: office@hydratech-slovakia.eu
http: www.hydratech-slovakia.eu

Spoločnosť je zapísaná v Obchodnom registri Okresného súdu Trnava, oddiel Sro, vložka č. 15610/T
The company is signed in the Companies register of The District Court Trnava, section Sro, insert No: 15610/T

REUSABLE FERRULES

R1AT

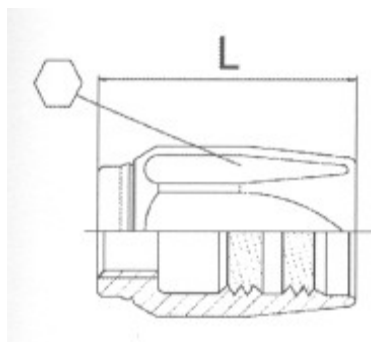

Code	Hose I.D.		Thread	Dimensions			Price in €
	DN	Poll		T	L	Ø	
R1AT03	4	3/16	-	40	-	-	
R1AT04	6	1/4	-	41	-	-	
R1AT05	8	5/16	-	46	-	-	
R1AT06	10	3/8	-	47	-	-	
R1AT08	12	1/2	-	53	-	-	
R1AT10	16	5/8	-	59	-	-	
R1AT12	20	3/4	-	66	-	-	
R1AT16	25	1	-	-	-	-	

R2AT

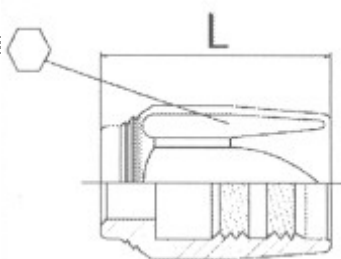

Code	Hose I.D.		Thread	Dimensions			Price in €
	DN	Poll		T	L	Ø	
R2AT03	4	3/16	-	40	-	-	
R2AT04	6	1/3	-	41	-	-	
R2AT05	8	5/16	-	47	-	-	
R2AT06	10	3/8	-	51	-	-	
R2AT08	12	1/2	-	54	-	-	
R2AT10	16	5/8	-	57	-	-	
R2AT12	20	3/4	-	67	-	-	
R2AT16	25	1	-	-	-	-	

42

address: ul Z. Kodályya 764/37
924 00 Galanta
Slovak republic

IČO: 36267091
IČ DPH: SK 2021917766
Account No.: 2629090057/1100
Skype: hydratech.s.r.o

tel:+421 31 780 42 46
fax:+421 31 780 42 45
email: office@hydrattech-slovakia.eu
http: www.hydrattech-slovakia.eu

Spoločnosť je zapísaná v Obchodnom registri Okresného súdu Trnava, oddiel Sro, vložka č. 15610/T
The company is signed in the Companies register of The District Court Trnava, section Sro, insert No: 15610/T

HYDRATECH s.r.o.

R5

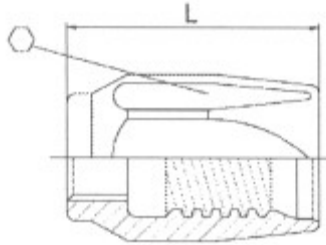

Code	Hose I.D.		Thread	Dimensions			Price in €
	DN	Poll		T	L	D	
R503	4	3/16	-	32	19	-	
R504	6	1/4	-	40	20	-	
R505	8	5/16	-	39	21	-	
R506	10	3/8	-	48	24	-	
R508	12	1/2	-	48	27	-	
R510	16	5/8	-	56	32	-	

Explanations:

R1AT, R2AT

R5

L,D

Reusable Ferrules

Dimensions according to the pictures in mm

Comments:

43

address: ul Z. Kodályya 764/37
924 00 Galanta
Slovak republic

IČO: 36267091
IČ DPH: SK 2021917766
Account No.: 2629090057/1100
Skype: hydratech.s.r.o

tel:+421 31 780 42 46
fax:+421 31 780 42 45
email: office@hydratech-slovakia.eu
<http://www.hydratech-slovakia.eu>

Spoločnosť je zapísaná v Obchodnom registri Okresného súdu Trnava, oddiel Sro, vložka č. 15610/T
The company is signed in the Companies register of The District Court Trnava, section Sro, insert No: 15610/T

BSP Straight Reusable Female

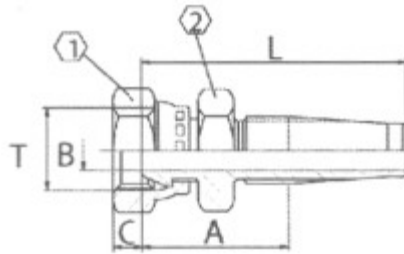

Code	Hose I.D.		Thread	Dimensions						Price in €
	DN	Poll		T	L	A	C	B	o ¹	
SRF02	4	3/16	1/8-28	53	24	6	3,5	14	14	
SRF04	6	1/4	1/4-19	58	29	5	4,5	19	19	
SRF06	6	1/4	3/8-19	60	31	6	7	22	22	
SRF06	8	5/16	3/8-19	59	31	6	7	22	22	
SRF06	10	3/8	3/8-19	68	31	6	7	22	22	
SRF08	13	1/2	1/2-14	73	30	7	9,5	27	27	
SRF10	13	1/2	5/8-14	72	29	10	12	28	28	
SRF10	16	5/8	5/8-14	77	32	10	12	28	28	
SRF12	16	5/8	3/4-14	80	35	10	15	32	32	
SRF12	20	3/4	3/4-14	87	39	10	15	32	32	
SRF16	20	3/4	1-11	89	41	11	20	38	38	
SRF16	25	1	1-11	98	46	11	20	38	38	

Explanations:

SRF BSP Straight Reusable Female – 60° cone – Crimped Nut
 o¹ o² Spanner 1 and Spanner 2
T Thread
L, A, C, B Dimensions according to the picture in mm

Comments:

BSP Resauble Elbow

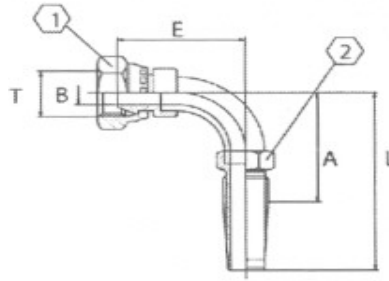

Code	Hose I.D.		Thread	Dimensions						Price in €
	DN	Poll		T	L	A	E	B	o ¹	
RE02	4	3/16	1/8-28	56	28	32	4	12	14	
RE04	4	3/16	1/4-19	57	29	34	5	12	19	
RE04	6	1/4	1/4-19	63	34	34	5	12	19	
RE06	6	1/4	3/8-19	69	40	41	8	16	22	
RE06	8	5/16	3/8-19	68	40	41	8	16	22	
RE06	10	3/8	3/8-19	77	40	41	8	16	22	
RE08	10	3/8	1/2-14	80	43	46	10	19	27	
RE08	13	1/2	1/2-14	83	40	46	10	19	27	
RE10	13	1/2	5/8-14	86	43	49	12	22	28	
RE10	16	5/8	5/8-14	91	46	49	12	22	28	
RE12	16	5/8	3/4-14	97	52	57	15	25	32	
RE12	20	3/4	3/4-14	104	56	57	15	25	32	
RE16	20	3/4	1-11	113	65	66	20	32	38	
RE16	25	1	1-11	122	70	66	20	32	38	

Explanations:

RE BSP 90° Reusable Elbow – 60° cone – Crimped Nut
o¹ o² Spanner 1 and Spanner 2
T Thread
L, A, E, B Dimensions according to the picture in mm

Comments:

BSP Reusable Male

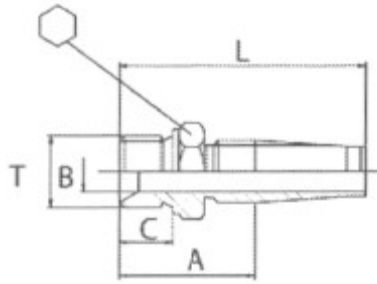

Code	Hose I.D.		Thread	Dimensions					Price in €
	DN	Poll		T	L	A	C	B	
RM02	4	3/16	1/8-28	55	26	10	3	14	
RM04	4	3/16	1/4-19	58	29	11	5	19	
RM04	6	1/4	1/4-19	59	30	11	5	19	
RM06	6	1/4	3/8-19	62	33	14	7,5	22	
RM06	8	5/16	3/8-19	61	33	14	7,5	22	
RM06	10	3/8	3/8-19	70	33	14	7	22	
RM08	10	3/8	1/2-14	72	35	15	9,5	27	
RM08	13	1/2	1/2-14	75	32	15	9,5	27	
RM10	13	1/2	5/8-14	77	34	17	12	28	
RM10	16	5/8	5/8-14	82	37	17	12	28	
RM12	16	5/8	3/4-14	85	40	19	15	32	
RM12	20	3/4	3/4-14	92	44	19	15	32	
RM16	20	3/4	1-11	96	48	22	20	41	
RM16	22	7/8	1-11	100	53	22	18	41	
RM16	25	1	1-11	105	53	22	20	41	
RM20	25	1	1.1/4-11	107	55	22	26	50	
RM20	32	1.1/4	1.1/4-11	116	61	22	26	50	
RM24	32	1.1/4	1.1/2-11	117	65	23	32	55	
RM24	40	1.1/2	1.1/2-11	124	70	23	32	55	
RM32	50	2	2-11	126	72	25	44	65	

Explanations:

RM	BSP Reusable Male – 60° cone
○	Spanner
T	Thread
L, A, C, B	Dimensions according to the picture in mm

Comments:

46

address: ul Z. Kodályya 764/37
924 00 Galanta
Slovak republic

IČO: 36267091
IČ DPH: SK 2021917766
Account No.: 2629090057/1100
Skype: hydratech.s.r.o

tel:+421 31 780 42 46
fax:+421 31 780 42 45
email: office@hydratech-slovakia.eu
http: www.hydratech-slovakia.eu

Spoločnosť je zapísaná v Obchodnom registri Okresného súdu Trnava, oddiel Sro, vložka č. 15610/T
The company is signed in the Companies register of The District Court Trnava, section Sro, insert No: 15610/T

Hydraulic ball valve

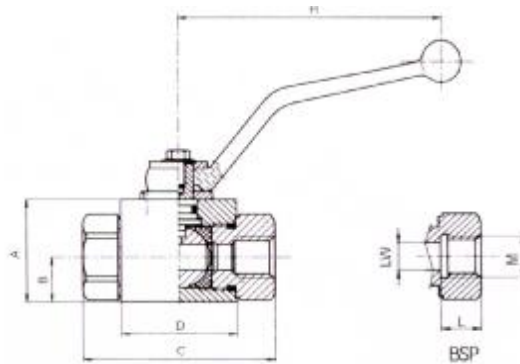

Code	Hose I.D.	Thread	Pressure	Dimensions						Price in €
				A	B	C	D	E	L	
HBV	DN	T	bar	A	B	C	D	E	L	
HBV02	04	1/8"	500	35	14	71	42	11	11	
HBV04	06	1/4"	500	35	14	71	42	11	16	
HBV06	10	3/8"	500	40	17	73	44	11	16	
HBV08	12	1/2"	500	43	18	83	48	11	17	
HBV10	20	3/4"	400	55	23	95	62	13	21	
HBV12	25	1"	350	65	29	113	66	13	24	
HBV14	25	1.1/4"	350	65	29	121	66	13	24	
HBV16	25	1.1/2"	350	65	29	124	66	13	24	

Explanations:

HBV Hydraulic ball valve
T Thread
Bar Pressure
A,B,C,D,E,L Dimensions according to the picture in mm

Comments:

47

address: ul Z. Kodálya 764/37
924 00 Galanta
Slovak republic

IČO: 36267091
IČ DPH: SK 2021917766
Account No.: 2629090057/1100
Skype: hydratech.s.r.o

tel:+421 31 780 42 46
fax:+421 31 780 42 45
email: office@hydratech-slovakia.eu
http: www.hydratech-slovakia.eu

Spoločnosť je zapísaná v Obchodnom registri Okresného súdu Trnava, oddiel Sro, vložka č. 15610/T
The company is signed in the Companies register of The District Court Trnava, section Sro, insert No: 15610/T

Quick coupling

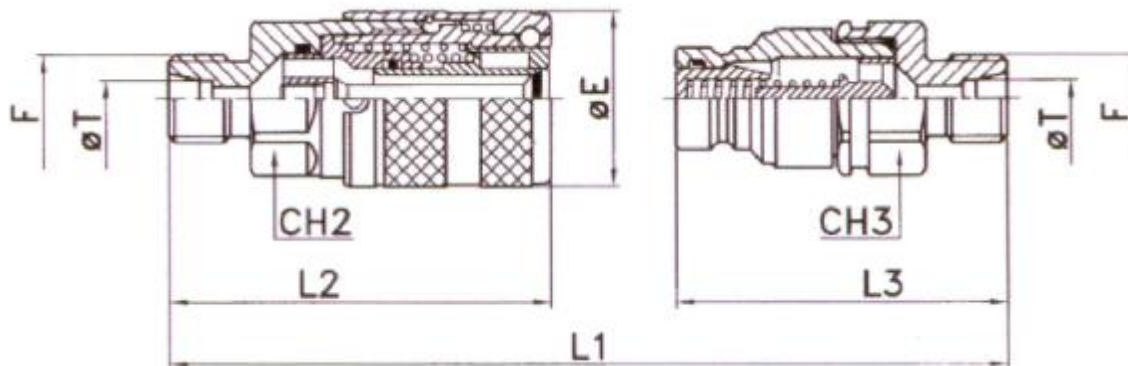

Code	Hose I.D.		Thread	Type			Price in €
	DN	Poll					
QC	12 L	3/8"	M 18x1,5	Male			
QC02	12 L	3/8"	M 18x1,5	Male			
QC03	12 L	3/8"	M 18x1,5	Female			
QC12	15 L	1/2"	M 22x1,5	Male			
QC13	15 L	1/2"	M 22x1,5	Female			
QC22	12 S	3/8"	M 20x1,5	Male			
QC23	12 S	3/8"	M 20x1,5	Female			
BSP QC 1102	12	1/2"	1/2"	Male			
BSP QC 1103	12	1/2"	1/2"	Female			

Explanations:

QC Quick coupling
BSP QC BSP Quick coupling
T Thread
Type Male/Female

Comments:

Manometer



Code	I.D.	Pressure	Thread	Tag	Description	Price in €
MNM	DN	bar	T	A/H		
MNM02	63	06	1/4"	A	Glycerine damping pressure gauge	
MNM04	63	10	1/4"	A	Glycerine damping pressure gauge	
MNM06	63	12	1/4"	A	Glycerine damping pressure gauge	
MNM08	63	16	1/4"	A	Glycerine damping pressure gauge	
MNM10	63	25	1/4"	A	Glycerine damping pressure gauge	
MNM12	63	40	1/4"	A	Glycerine damping pressure gauge	
MNM14	63	60	1/4"	A	Glycerine damping pressure gauge	
MNM16	63	80	1/4"	A	Glycerine damping pressure gauge	
MNM18	63	100	1/4"	A	Glycerine damping pressure gauge	
MNM20	63	160	1/4"	A	Glycerine damping pressure gauge	
MNM22	63	250	1/4"	A	Glycerine damping pressure gauge	
MNM24	63	300	1/4"	A	Glycerine damping pressure gauge	
MNM26	63	400	1/4"	A	Glycerine damping pressure gauge	
MNM28	63	600	1/4"	A	Glycerine damping pressure gauge	
MNM30	63	1000	1/4"	A	Glycerine damping pressure gauge	
MNM52	63	06	1/4"	H	Glycerine damping pressure gauge	
MNM54	63	10	1/4"	H	Glycerine damping pressure gauge	
MNM56	63	12	1/4"	H	Glycerine damping pressure gauge	
MNM58	63	16	1/4"	H	Glycerine damping pressure gauge	
MNM60	63	25	1/4"	H	Glycerine damping pressure gauge	
MNM62	63	40	1/4"	H	Glycerine damping pressure gauge	
MNM64	63	60	1/4"	H	Glycerine damping pressure gauge	
MNM66	63	80	1/4"	H	Glycerine damping pressure gauge	
MNM68	63	100	1/4"	H	Glycerine damping pressure gauge	
MNM70	63	160	1/4"	H	Glycerine damping pressure gauge	
MNM72	63	250	1/4"	H	Glycerine damping pressure gauge	
MNM74	63	300	1/4"	H	Glycerine damping pressure gauge	
MNM76	63	400	1/4"	H	Glycerine damping pressure gauge	
MNM78	63	600	1/4"	H	Glycerine damping pressure gauge	

Explanations:

MNM Manometer
A/H A - bottom H - backside

Conclusion

We highly appreciate that in nowadays and challenging time you've spent your time with reading our catalogue. It really means a great pleasure for us.

We emphasize that this catalogue doesn't concern the whole range of our products. Being interested in products which are not concerned in this catalogue or for further information please do not hesitate and contact us. We'll do our best to satisfy your demand.

We are looking forward to do cooperation with you.

Hydratech s.r.o.
Team

HYDRATECH s.r.o.

© **Hydratech s.r.o.** 2007

HYDRATECH s.r.o.